



OPERATION MANUAL

■ T-60FP



■ T-120FP



■ T-240FP



■ T-350FP

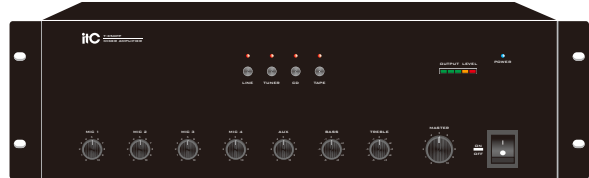

■ T-500FP

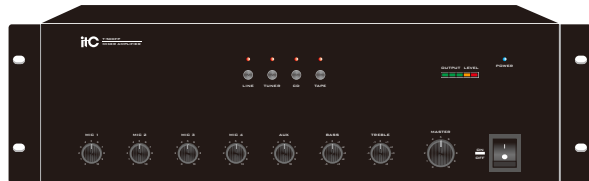

Please follow the instructions in this manual to obtain the optimum results from this unit.
We also recommend that you keep this manual handy for future reference.

TABLE OF CONTENTS

1. GENERAL DESCRIPTION	5
2. FEATURES	5
3. NOMENCLATURE AND FUNCTIONS	
3.1 Front Panel	6
3.2 Rear Panel.....	8
4. CONNECTIONS	
4.1. Speaker Connections	11
4.2. XLR Connections	11
5. MACHINE OPERATION.....	12
6. APPLICATIONS	13
7. SPECIFICATIONS	16
8. DIMENSIONAL DIAGRAM	18

SAFETY PRECAUTIONS

- Be sure to read the instructions in this section carefully before use.
- Make sure to observe the instructions in this manual as the conventions of safety symbols and messages regarded as very important precautions are included.
- We also recommend you keep this instruction manual handy for future reference.

Safety Symbol and Message Conventions

Safety symbols and messages described below are used in this manual to prevent bodily injury and property damage which could result from mishandling. Before operating your product, read this manual first and understand the safety symbols and messages so you are thoroughly aware of the potential safety



WARNING

Indicates a potentially hazardous situation which, if mishandled, could result in death or serious personal injury.



CAUTION

Indicates a potentially hazardous situation which, if mishandled, could result in moderate or minor personal injury, and/or property damage.



WARNING

When Installing the Unit

- Do not expose the unit to rain or an environment where it may be splashed by water or other liquids, as doing so may result in fire or electric shock.
- Use the unit only with the voltage specified on the unit. Using a voltage higher than that which is specified may result in fire or electric shock.
- Do not cut, kink, otherwise damage nor modify the power supply cord. In addition, avoid using the power cord in close proximity to heaters, and never place heavy objects -- including the unit itself -- on the power cord, as doing so may result in fire or electric shock.
- Be sure to replace the unit's terminal cover after connection completion. Because high voltage is applied to the speaker terminals, never touch these terminals to avoid electric shock.
- Be sure to ground to the safety ground (earth) terminal to avoid electric shock. Never ground to a gas pipe as a catastrophic disaster may result.
- Avoid installing or mounting the unit in unstable locations, such as on a rickety table or a slanted surface. Doing so may result in the unit falling down, causing personal injury and/or property damage.

When the Unit is in Use

- Should the following irregularity be found during use, immediately switch off the power, disconnect the power supply plug from the AC outlet and contact your nearest **ITC** dealer. Make no further attempt to operate the unit in this condition as this may cause fire or electric shock.
 - If you detect smoke or a strange smell coming from the unit.
 - If water or any metallic object gets into the unit
 - If the unit falls, or the unit case breaks
 - If the power supply cord is damaged (exposure of the core, disconnection, etc.)
 - If it is malfunctioning (no tone sounds.)
- To prevent a fire or electric shock, never open nor remove the unit case as there are high voltage components inside the unit. Refer all servicing to your nearest **ITC** dealer.
- Do not place cups, bowls, or other containers of liquid or metallic objects on top of the unit. If they accidentally spill into the unit, this may cause a fire or electric shock.
- Do not insert nor drop metallic objects or flammable materials in the ventilation slots of the unit's cover, as this may result in fire or electric shock.

CAUTION

When Installing the Unit

- Never plug in nor remove the power supply plug with wet hands, as doing so may cause electric shock.
- When unplugging the power supply cord, be sure to grasp the power supply plug; never pull on the cord itself. Operating the unit with a damaged power supply cord may cause a fire or electric shock.
- When moving the unit, be sure to remove its power supply cord from the wall outlet. Moving the unit with the power cord connected to the outlet may cause damage to the power cord, resulting in fire or electric shock. When removing the power cord, be sure to hold its plug to pull.
- Do not block the ventilation slots in the unit's cover. Doing so may cause heat to build up inside the unit and result in fire.
- Avoid installing the unit in humid or dusty locations, in locations exposed to the direct sunlight, near the heaters, or in locations generating sooty smoke or steam as doing otherwise may result in fire or electric shock.

When the Unit is in Use

- Do not place heavy objects on the unit as this may cause it to fall or break which may result in personal injury and/or property damage. In addition, the object itself may fall off and cause injury and/or damage.
- Make sure that the volume control is set to minimum position before power is switched on. Loud noise produced at high volume when power is switched on can impair hearing.
- Do not operate the unit for an extended period of time with the sound distorting. This is an indication of a malfunction, which in turn can cause heat to generate and result in a fire.
- Contact your **ITC** dealer as to the cleaning. If dust is allowed to accumulate in the unit over a long period of time, a fire or damage to the unit may result.
- If dust accumulates on the power supply plug or in the wall AC outlet, a fire may result. Clean it periodically. In addition, insert the plug in the wall outlet securely.
- Switch off the power, and unplug the power supply plug from the AC outlet for safety purposes when cleaning or leaving the unit unused for 10 days or more. Doing otherwise may cause a fire or electric shock.

An all-pole mains switch with a contact separation of at least 3 mm in each pole shall be incorporated in the electrical installation of the building.

1. GENERAL DESCRIPTION

ITC series of public address mixer amplifiers have power ratings from 60 to 500 watts RMS, these sleek, attractive units provide a compact solution for PA system amplification and distribution.

2. FEATURES

- Rated power output from 60W, 120W, 240W, 350W and 500W.
- AC and DC 24V operation.
- Special Low Cut filter built-in.
- Level meter and power indicator.
- Phoenix connector for easy installation.
- 4 Aux input, with inter-lock to avoid blending.
- Built-in 2 tone and 4 tone chime two options.
- Pre OUT for other signal processing equipments.
- Individual input volume and master volume control.
- Current limiter, overloading, short circuit and thermal protection.
- With remote priority input to select background music when paging.
- 4 balanced XLR mic input with selectable priority and each with phantom power.
- Constant voltage 100V and 70V and 50V lines and low impedance 4 ohms and 8 ohms speaker terminal
- Constant voltage 100V and 70V and 50V lines and low impedance 4 ohms and 8 ohms speaker terminal 3. 4
Aux input, with inter-lock to avoid blending

3. NOMENCLATURE AND FUNCTIONS

3.1 60W120W/240W FRONT PANEL

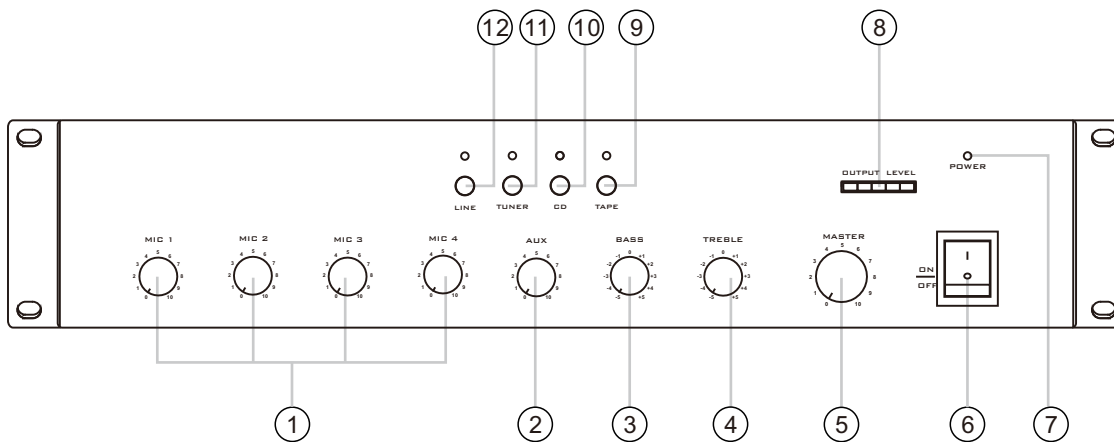

1. MIC1 \ MIC2 \ MIC3 \ MIC4

MIC volume control (MIC1/MIC2/MIC3/MIC4)

2. AUX

AUX volume control

3. BASS

Adjust bass response. Rotate clockwise to increase bass output and anticlockwise to reduce it.

4. TREBLE

Adjust treble response. Rotate clockwise to increase treble output and anticlockwise to reduce it.

5. MASTER

Master volume control

6. POWER SWITCH

On top of the opening Power

Press the end, power shut down

7. POWER

Power indicator

8. OUTPUT LEVEL

Power level indicator

9. TAPE

Select tape channel input keyswitch

10. CD

Select CD channel input keyswitch

11. TUNER

Select tuner channel input keyswitch

12. LINE

Select line channel input keyswitch

NOMENCLATURE AND FUNCTIONS

350/500W FRONT PANEL

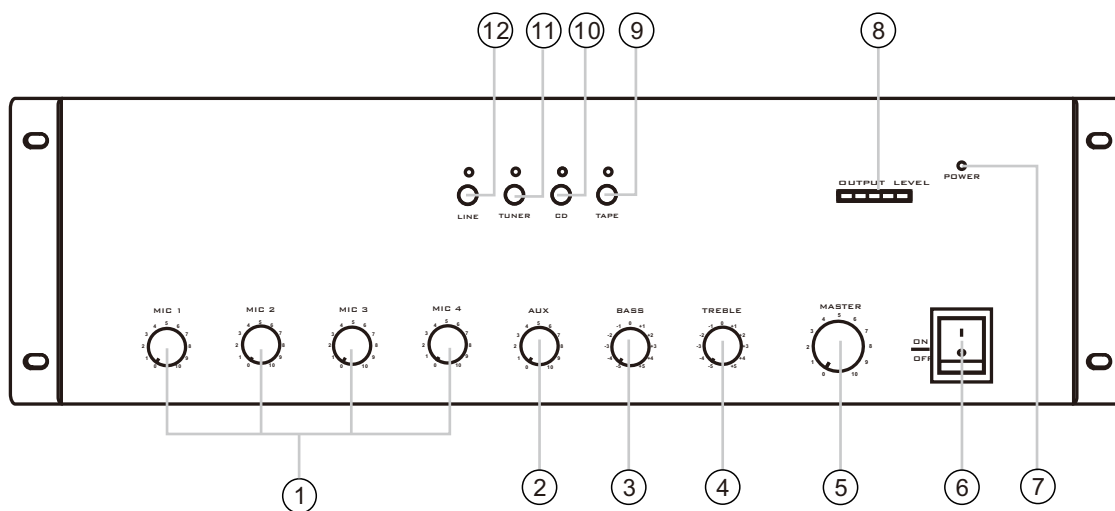

1. MIC1 \ MIC2 \ MIC3 \ MIC4

MIC volume control (MIC1/MIC2/MIC3/MIC4)

2. AUX

AUX volume control

3. BASS

Adjust bass response. Rotate clockwise to increase bass output and anticlockwise to reduce it.

4. TREBLE

Adjust treble response. Rotate clockwise to increase treble output and anticlockwise to reduce it.

5. MASTER

Master volume control

6. POWER SWITCH

On top of the opening Power

Press the end, power shut down

7. POWER

power indicator

8. OUTPUT LEVEL

Power level indicator

9. TAPE

Select tape channel input keyswitch

10.CD

Select CD channel input keyswitch

11.TUNER

Select tuner channel input keyswitch

12.LINE

Select line channel input keyswitch

NOMENCLATURE AND FUNCTIONS

3.2 60W/120W REAL PANEL

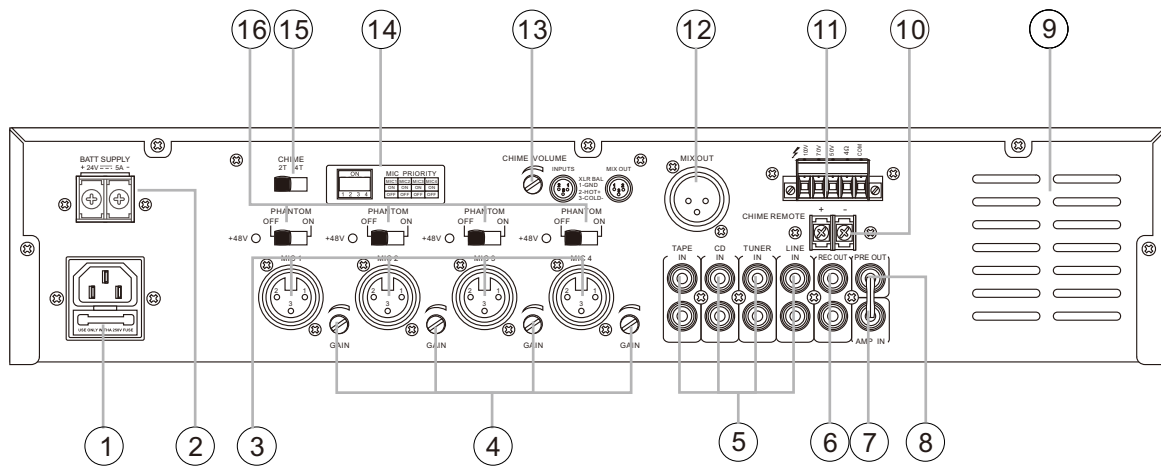

1. **AC POWER INPUT**
2. **24V DC BATT SUPPLY**
3. **MIC(1~4)**
MICRO(1~4)microphone input
4. **GAIN**
MICRO(1~4) microphone gain control
5. **TAPE CD TUNER LINE**
Audio source interface
6. **REC OUT**
To recorder interface
7. **AMP IN**
Form effect return interface
8. **PRE OUT**
To effect input interface
9. **COOLING FANS**
10. **BELL TRIGGER**
11. **SPEAKER TERMINALS**
Connectors for 4 ohms or 50V / 70V and 100V speaker

12. **MIX OUT**
Audio output
13. **CHIME VOLUME**
Chime volume control
14. **MIC(1-4) PRIORITY DIALING SWITCH**

MIC PRIORITY

MIC1	MIC2	MIC3	MIC4
ON	ON	ON	ON
OFF	OFF	OFF	OFF

When the MIC (1~4) address code switch be switched "ON", indicate the MIC (1~4) is balance input priority.
When the MIC (1~4) address code switch be switched "OFF", indicate the balance input priority of MIC (1~4) is off.

15. **CHIME(2 Tone\4 Tone)**
Chime(2 Tone\4 Tone) volume Control
16. **PHANTOM POWER**
MIC(1~4) phantom power select switch
When set to the "OFF" position, phantom power is turned off on inputs 1-4. When set to the "ON" position, phantom power (DC 48V) is available on INPUTS 1-4 (mic position only).

NOMENCLATURE AND FUNCTIONS

240W REAR PANEL

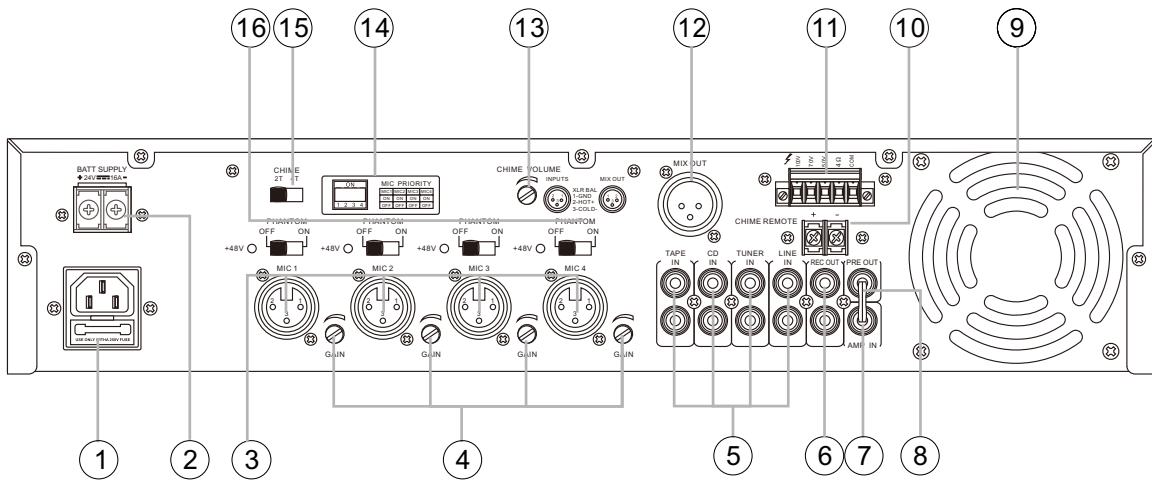

1. **AC POWER INPUT**
2. **24V DC BATT SUPPLY**
3. **MIC(1~4)**
MICRO(1~4)microphone input
4. **GAIN**
MICRO(1~4) microphone gain control
5. **TAPE CD TUNER LINE**
Audio source interface
6. **REC OUT**
To recorder interface
7. **AMP IN**
Form effect return interface
8. **PRE OUT**
To effect input interface
9. **COOLING FANS**
10. **BELL TRIGGER**
11. **SPEAKER TERMINALS**
Connectors for 4 ohms or 50V / 70V and 100V speaker

12. **MIX OUT**
Audio output
13. **CHIME VOLUME**
Chime volume control
14. **MIC(1-4) PRIORITY DIALING SWITCH**
MIC PRIORITY

MIC1	MIC2	MIC3	MIC4
ON	ON	ON	ON
OFF	OFF	OFF	OFF

When the MIC (1~4) address code switch be switched "ON", indicate the MIC (1~4) is balance input priority.
When the MIC (1~4) address code switch be switched "OFF", indicate the balance input priority of MIC (1~4) is off.

15. **CHIME(2 Tone\4 Tone)**
Chime(2 Tone\4 Tone) volume Control
16. **PHANTOM POWER**
MIC(1~4) phantom power select switch
When set to the "OFF" position, phantom power is turned off on inputs 1-4. When set to the "ON" position, phantom power (DC 48V) is available on INPUTS 1-4 (mic position only).

NOMENCLATURE AND FUNCTIONS

350W/500W REAR PANEL

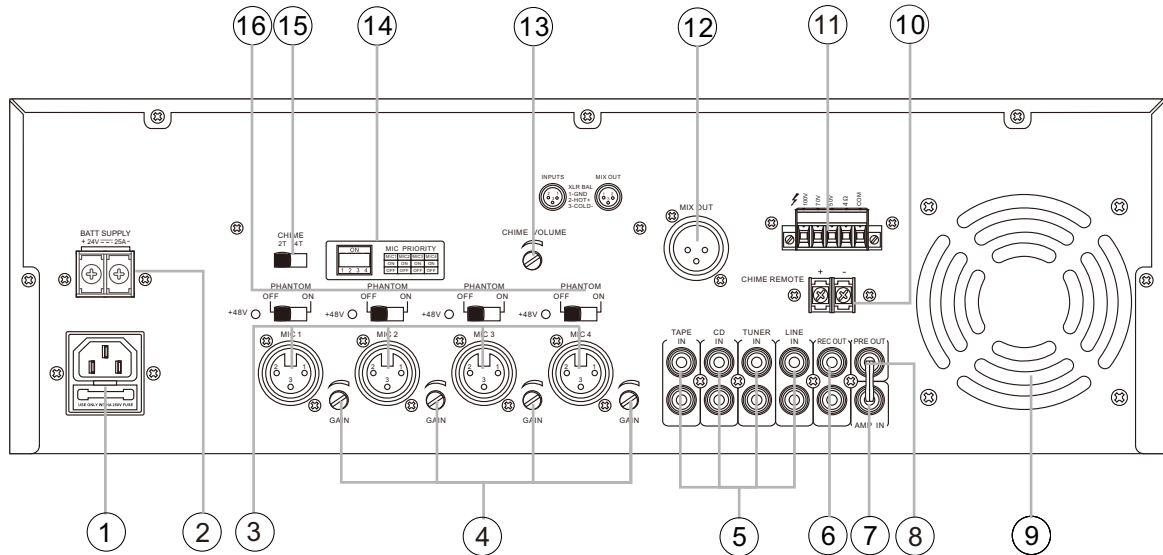

1. **AC POWER INPUT**
2. **24V DC BATT SUPPLY**
3. **MIC(1~4)**
MICRO(1~4)microphone input
4. **GAIN**
MICRO(1~4) microphone gain control
5. **TAPE CD TUNER LINE**
Audio source interface
6. **REC OUT**
To recorder interface
7. **AMP IN**
Form effect return interface
8. **PRE OUT**
To effect input interface
9. **COOLING FANS**
10. **BELL TRIGGER**
11. **SPEAKER TERMINALS**
Connectors for 4 ohms or 50V / 70V and 100V speaker

12. **MIX OUT**
Audio output
13. **CHIME VOLUME**
Chime volume control
14. **MIC(1-4) PRIORITY DIALING SWITCH**
MIC PRIORITY

MIC1	MIC2	MIC3	MIC4
ON	ON	ON	ON
OFF	OFF	OFF	OFF

When the MIC (1~4) address code switch be switched "ON", indicate the MIC (1~4) is balance input priority.
When the MIC (1~4) address code switch be switched "OFF", indicate the balance input priority of MIC (1~4) is off.

15. **CHIME(2 Tone\4 Tone)**
Chime(2 Tone\4 Tone) volume Control
16. **PHANTOM POWER**
MIC(1~4) phantom power select switch
When set to the "OFF" position, phantom power is turned off on inputs 1-4. When set to the "ON" position, phantom power (DC 48V) is available on INPUTS 1-4 (mic position only).

4. CONNECTIONS

4.1 SPEAKER CONNECTIONS

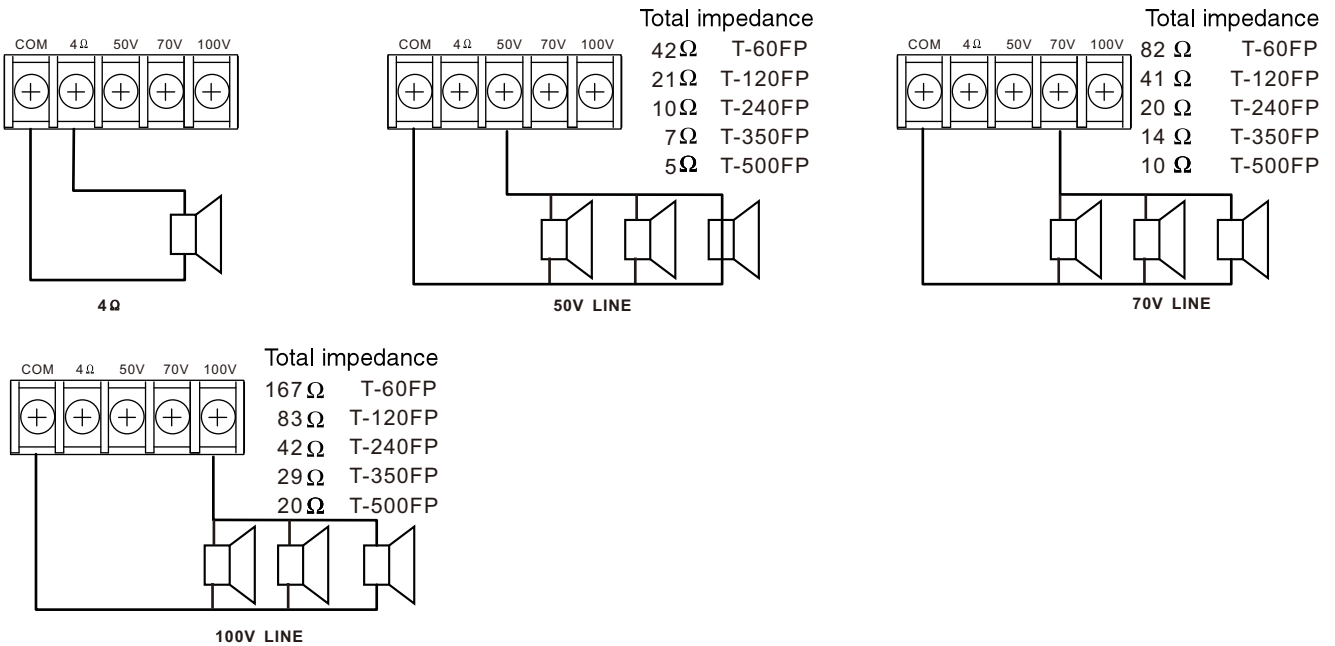

Notes

- Both the 4 Ω and 50V\70V\100 V terminals cannot be used at the same time.
- Impedances indicated in the figures represent the total speaker system (load) impedances.

WARNING

Be sure to attach the supplied terminal cover after connection completion. Because high voltage is applied to the speaker terminals, never touch these terminals to avoid electric shock.

4.2 XLR CONNECTIONS

Combined XLR (female)/phone jack connectors.

Usable connectors and plugs

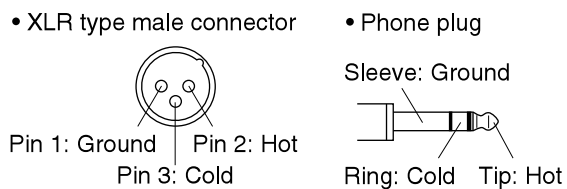

5. MACHINE OPERATION

OPERATION ATTENTION

- 1 Do not open and close the machine frequently. Reopen should be after 10 seconds.
- 2 Power supply should match up to the machine.
- 3 The machine outfit with ground line, so please plug on the connected-ground wire-net
- 4 As formidable shock or impact on machine such as (thunder shock, halfway signal pause, excess rated signal input or other interference), the machine will auto-check and reopen automatically.

6. APPLICATIONS

60W/120W REAR PANEL CONNECTIONS

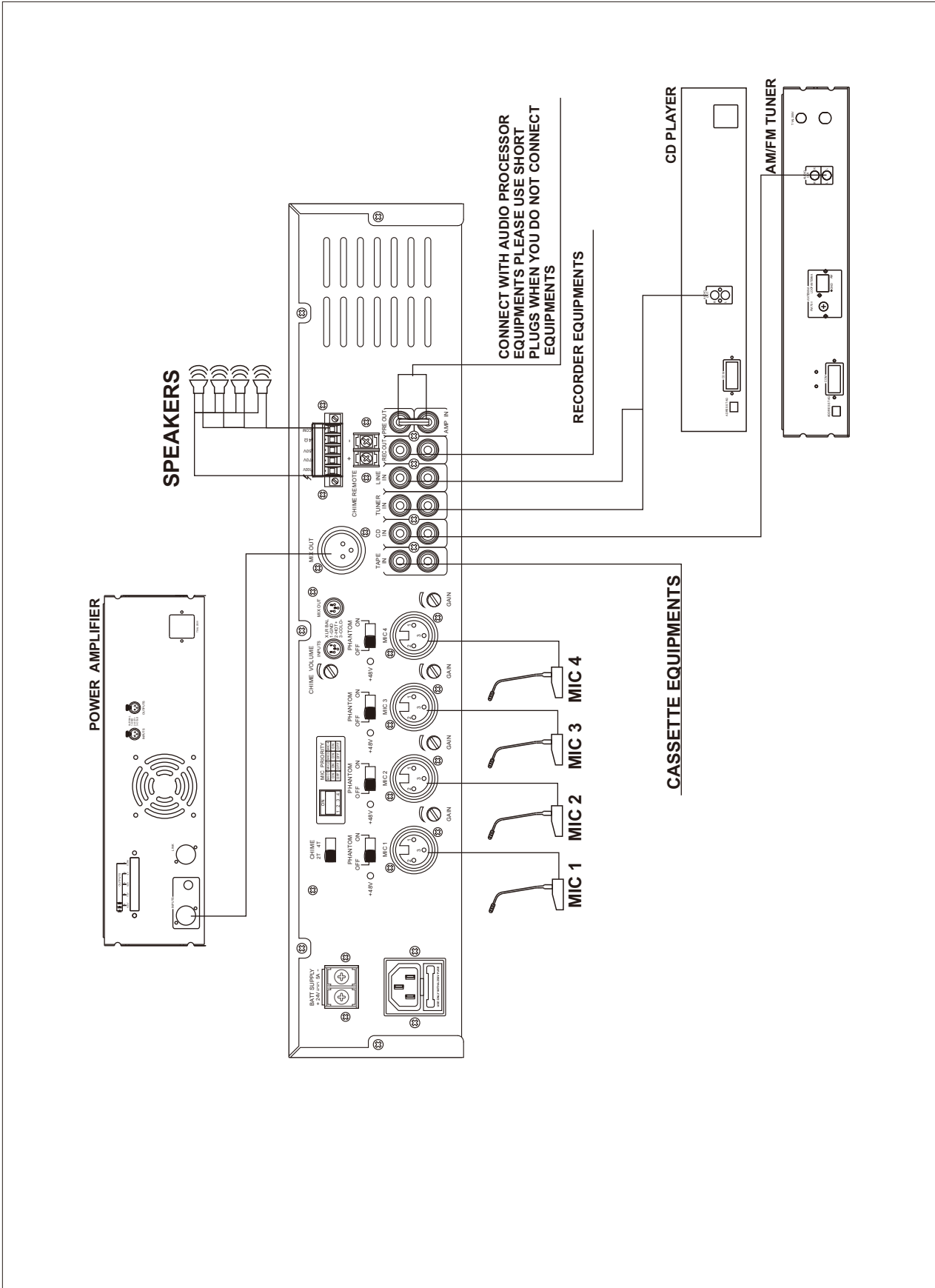

APPLICATIONS

240W REAR PANEL CONNECTIONS

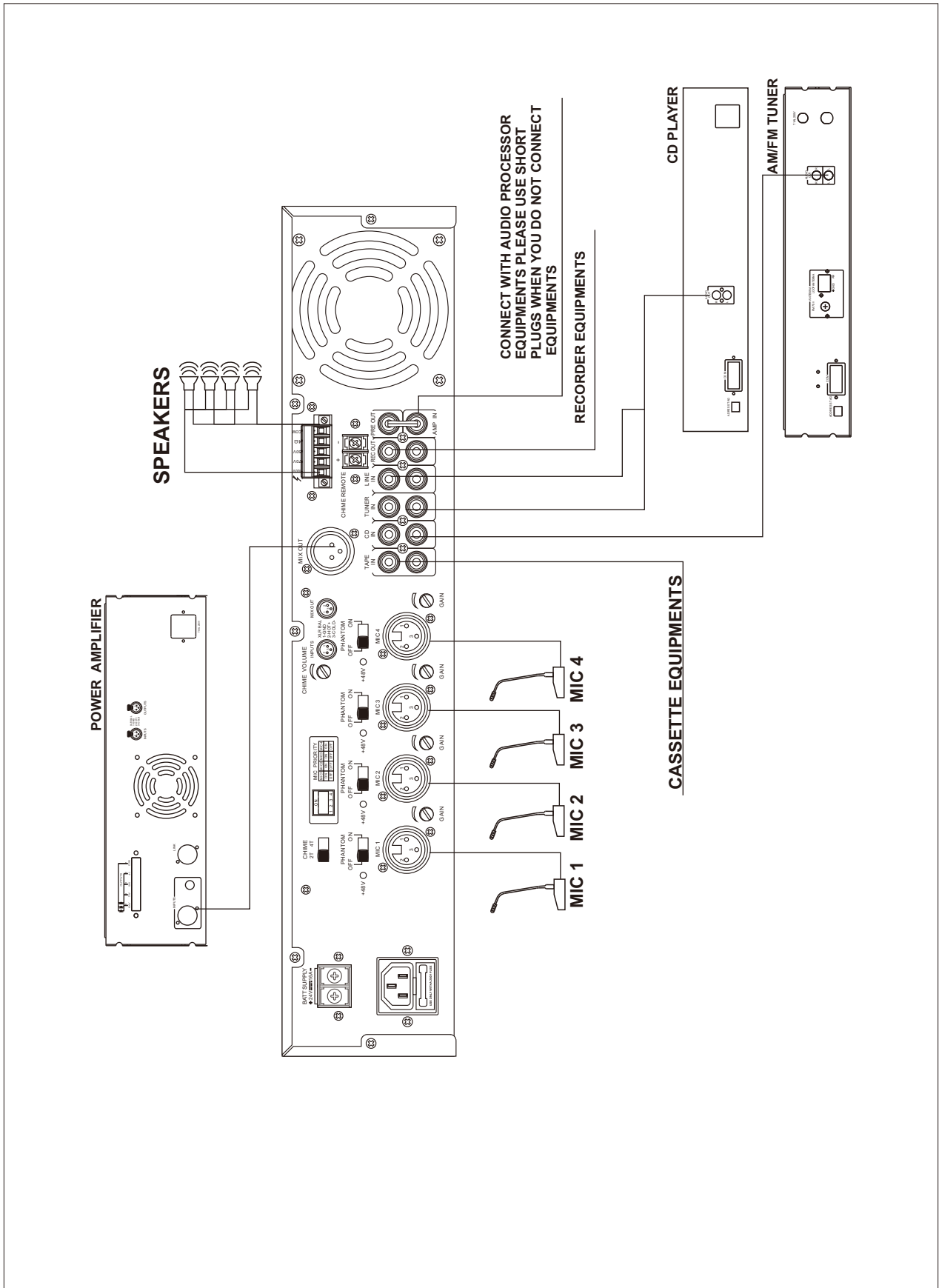

APPLICATIONS

350W/500W REAR PANEL CONNECTIONS

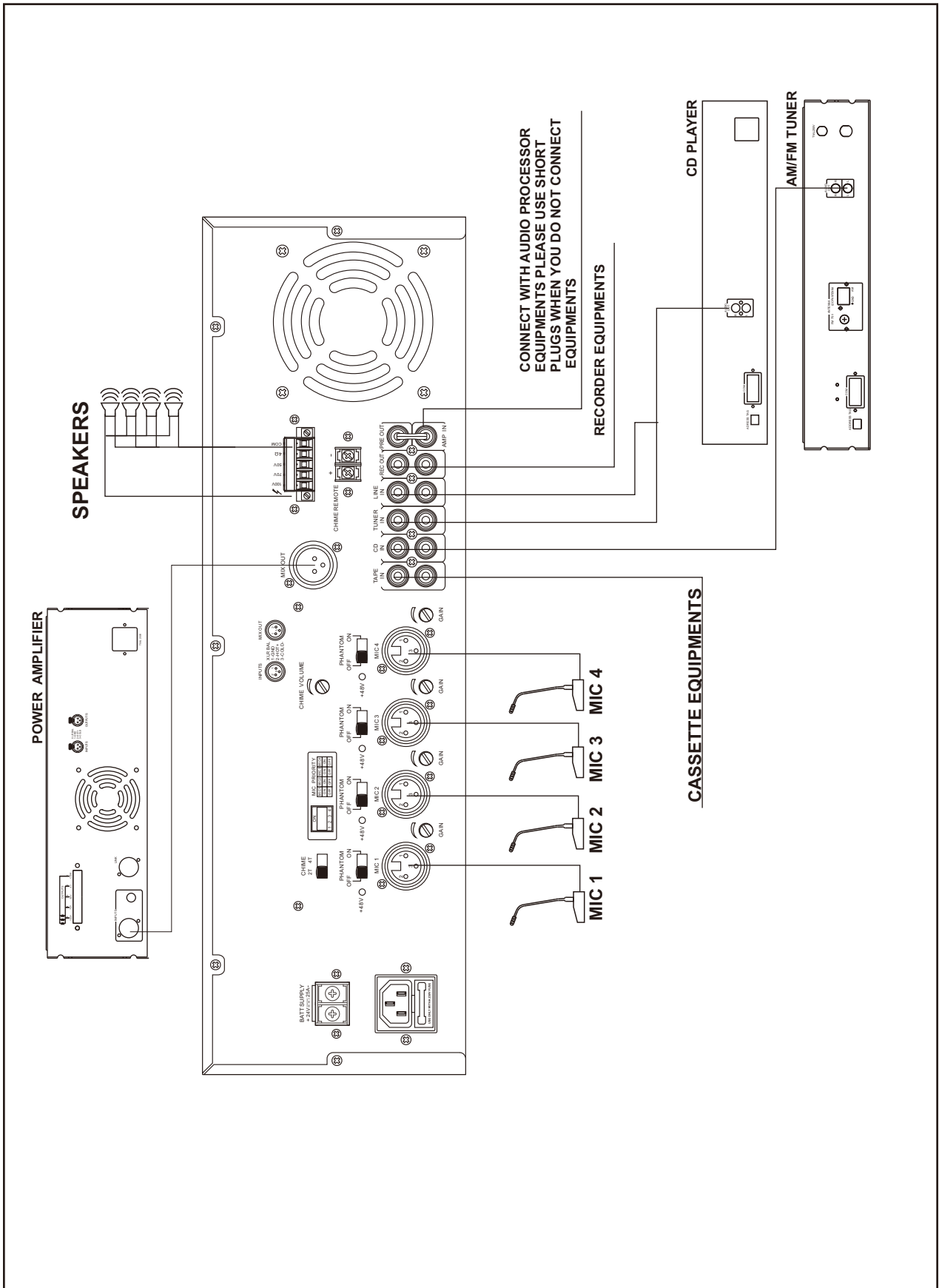

7. SPECIFICATIONS

MIXER AMPLIFIER			
MODEL(2U)	T-60FP	T-120FP	T-240FP
4 MICROPHONE INPUTS	±2.5~100mV/2K XLR balanced with phantom power		
PHANTOM POWER	+48V		
4 AUXILIARY INPUTS			
TUNER AND TAPE INPUTS SENSIVITY/IMPEDANCE	350 mV/47KΩ		
CD AND LINE INPUTS SENSIVITY/IMPEDANCE	350 mV/47KΩ		
SIGNAL TO NOISE RATIO	>75 dB		
FREQUENCY RESPONSE	50Hz-16KHz (+1,-3dB)		
CONTROL			
BASS	±10 dB		
TREBLE	±10 dB		
CHIME	2 tone and 4 tone options		
OUTPUTS			
OUTPUT ELECTRO/IMPEDANCE	1000mV/470Ω		
OUTPUT REC/IMPEDANCE	200mV/470Ω		
DISTORTION	< 0.1%		
OPERATING CONDITION			
AC MAINS INPUT	<input type="checkbox"/> ~110V 50Hz <input type="checkbox"/> ~110V 60Hz <input type="checkbox"/> ~120V 50Hz <input type="checkbox"/> ~120V 60Hz <input type="checkbox"/> ~220V 50Hz <input type="checkbox"/> ~220V 60Hz <input type="checkbox"/> ~230V 50Hz <input type="checkbox"/> ~230V 60Hz <input type="checkbox"/> ~240V 50Hz <input type="checkbox"/> ~240V 60Hz		
DIMENSIONS (D X W X H)mm	484X353X88		484X385X88
POWER CONSUMPTION	100W	200W	400W
WEIGHT	8.1Kg	9.4Kg	13.2Kg

SPECIFICATIONS

MIXER AMPLIFIER		
MODEL(3U)	T-350FP	T-500FP
4 MICROPHONE INPUTS	±2.5~100mV/2K XLR balanced with phantom power	
PHANTOM POWER	+48V	
4 AUXILIARY INPUTS		
TUNER AND TAPE INPUTS SENSIVITY/IMPEDANCE	350mV/47KΩ	
CD AND LINE INPUTS SENSIVITY/IMPEDANCE	350mV/47KΩ	
SIGNAL TO NOISE RATIO	>75 dB	
FREQUENCY RESPONSE	50Hz-16KHz (+1,-3dB)	
CONTROL		
BASS	±10 dB	
TREBLE	±10 dB	
CHIME	2 tone and 4 tone options	
OUTPUTS		
OUTPUT ELECTRO/IMPEDANCE	1000mV/470Ω	
OUTPUT REC/IMPEDANCE	200mV/470Ω	
DISTORTION	< 0.1%	
OPERATING CONDITION		
AC MAINS INPUT	<input type="checkbox"/> ~110V 50Hz <input type="checkbox"/> ~110V 60Hz <input type="checkbox"/> ~120V 50Hz <input type="checkbox"/> ~120V 60Hz <input type="checkbox"/> ~220V 50Hz <input type="checkbox"/> ~220V 60Hz <input type="checkbox"/> ~230V 50Hz <input type="checkbox"/> ~230V 60Hz <input type="checkbox"/> ~240V 50Hz <input type="checkbox"/> ~240V 60Hz	
DIMENSIONS (D X W X H)mm	484X424X132	
POWER CONSUMPTION	500W	750W
WEIGHT	15.4Kg	17.3Kg

8. DIMENSIONAL DIAGRAM

60W/120W UNIT :mm

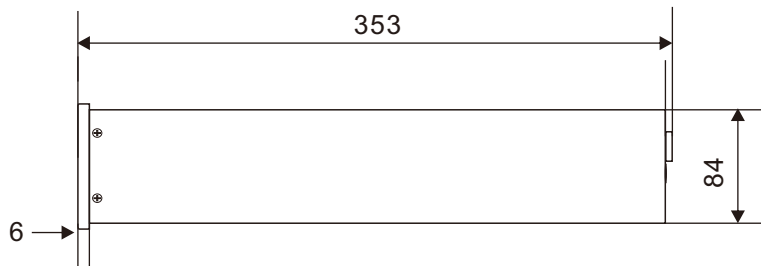
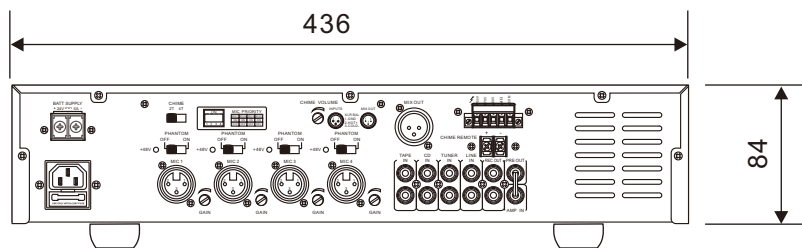
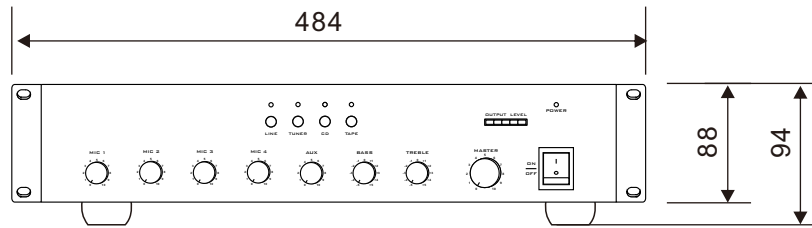

Keep the unit's all sides over 10 cm away from objects that may obstruct air flow to prevent the unit's internal temperature rise.

UNIT :mm

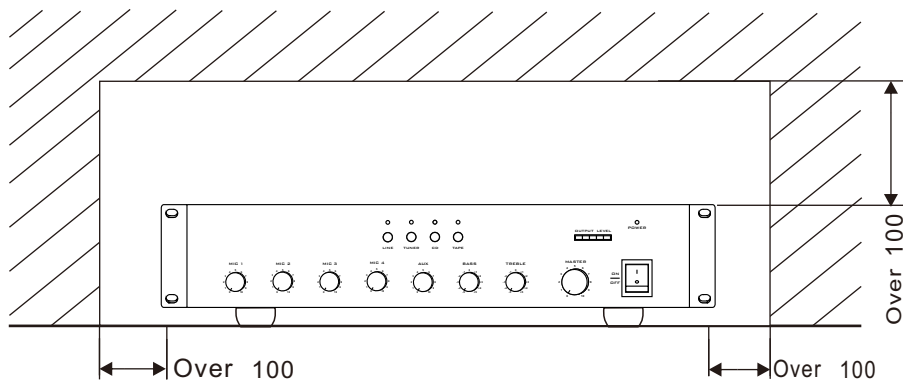

DIMENSIONAL DIAGRAM

240W UNIT :mm

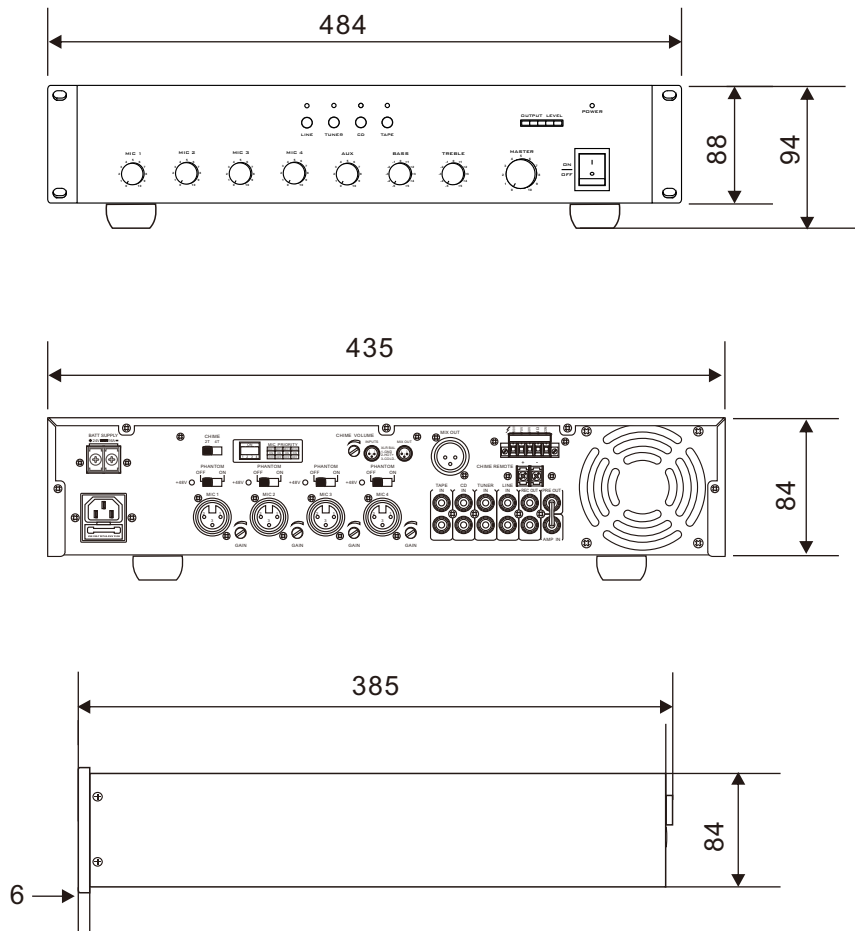

Keep the unit's all sides over 10 cm away from objects that may obstruct air flow to prevent the unit's internal temperature rise.

UNIT :mm

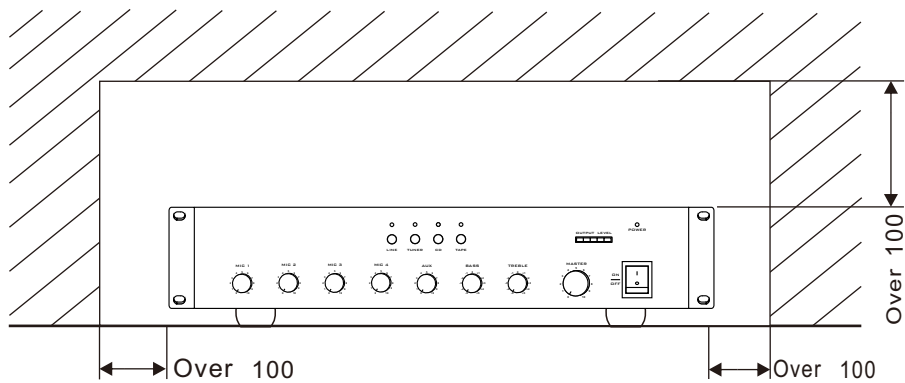

DIMENSIONAL DIAGRAM

350W/500W UNIT :mm

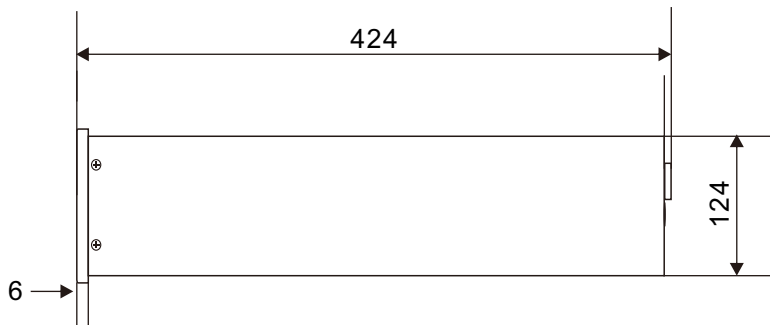
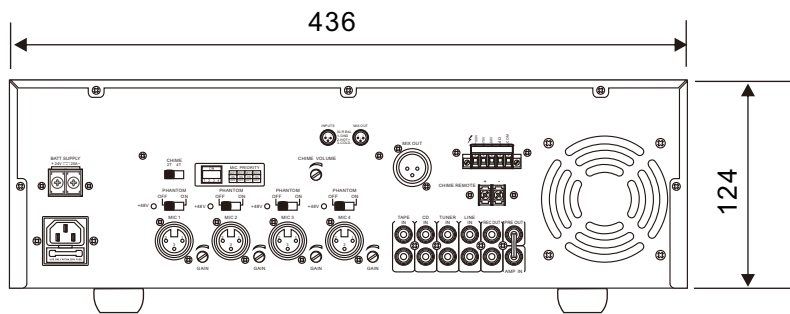
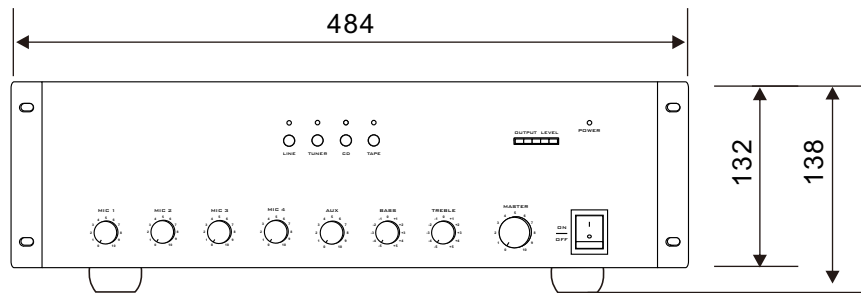

Keep the unit's all sides over 10 cm away from objects that may obstruct air flow to prevent the unit's internal temperature rise.

UNIT :mm

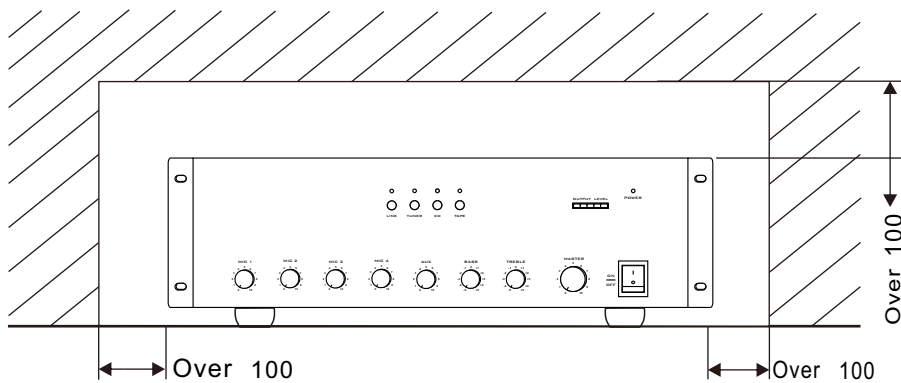

PUBLIC ADDRESS SYSTEM

